

PHOTONICS WORKSHOP

PHOTONICS CUDDLY TOY

DISCLAIMER:

By using this information you agree to be legally bound by these terms, which shall take effect immediately on your first use of the information.

PHABLABS 4.0 consortium and its member organizations give no warranty that the provided information is accurate, up-to-date or complete. You are responsible for independently verifying the information. VUB cannot be held liable for any loss or damage that may arise directly or indirectly from the use of or reliance on the information and/or products provided. PHABLABS 4.0 consortium and its member organizations disclaim all responsibility to the maximum extent possible under applicable laws:

- All express or implied warranties in relation to the information and your use of it are excluded.
- All liability, including for negligence, to you arising directly or indirectly in connection with the information or from your use of it is excluded.

This instruction is published under the Creative Commons licence CC-BY-NC.

PROPERTIES OF THIS WORKSHOP



SUMMARY:

The participants will enhance their cuddly toy, dinosaur or a different object with light, using one light source and a bundle of plastic optical fibres to guide the light to several places on the object for illumination purposes.

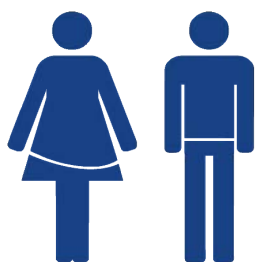

TARGET AUDIENCE:

Young students (10-14 years old)

SUGGESTED TIME PLANNING: (Total: 3h)



Timing in minutes	Activity
0 - 15	Welcome group and explaining of the concept of 'Total Internal Reflection'
15 - 60	Implementing the optical fibres and bringing light to the surface.
60 - 150	Controlling and implementing electronics
150 - 180	Finishing your very own Teddy Bear



TOOLS:

Laser Cutter
Sewing Machine
Soldering Iron (not necessary)



ESTIMATED COST:

€15

Step 1: Total Internal Reflection?

Bringing light to several places in the cuddly toy is based on **total internal reflection**.

It is very important to explain the participants of the workshop how total internal reflection works. This can be done on a very basic way.

Let's start explaining that light goes in straight lines. Ask the participants what path the light takes - does it follow an arc, like a ball thrown in the air, or does it go straight? Then ask the participants how they can prove their answer, ideally with an experiment. If they do not find a suitable experiment, you might suggest the following one (but only then):

One participant holds a light source and sends light signals, while another observes the light source from a few meters away. You can then ask a third participant to cover the light source with one hand and slowly move the hand towards the observer, so that the light source remains occluded. The other participant observe the trajectory of the hand and see that it follows a straight line between the light sources and the eye of the observer.



If the participants then understand that light goes in straight lines, it's time to show them another property of light: reflection. To study the reflection, place an obstacle, e.g. your bag, on a table. Place two participants on each side of the table and ask the participants how they could send light signals around the bag which is hindering the direct view. Most probably they will suggest the use of a mirror to 'see around the bag'. Give one participant a flash light. Let the participants know that you expect them to give you clear instructions on how to place a mirror on the table, such that the light signals can be sent between them.



Reflection is a property that you find very often in nature. For example, objects in the air can be reflected on a water surface. But this principle works vice versa as well, objects in water will also be reflected on the water surface.

Total internal reflection is the phenomena where light gets reflected inside a particular material over and over again. The angle of incidence is larger than a particular critical angle (θ_c) with respect to the normal to the surface.

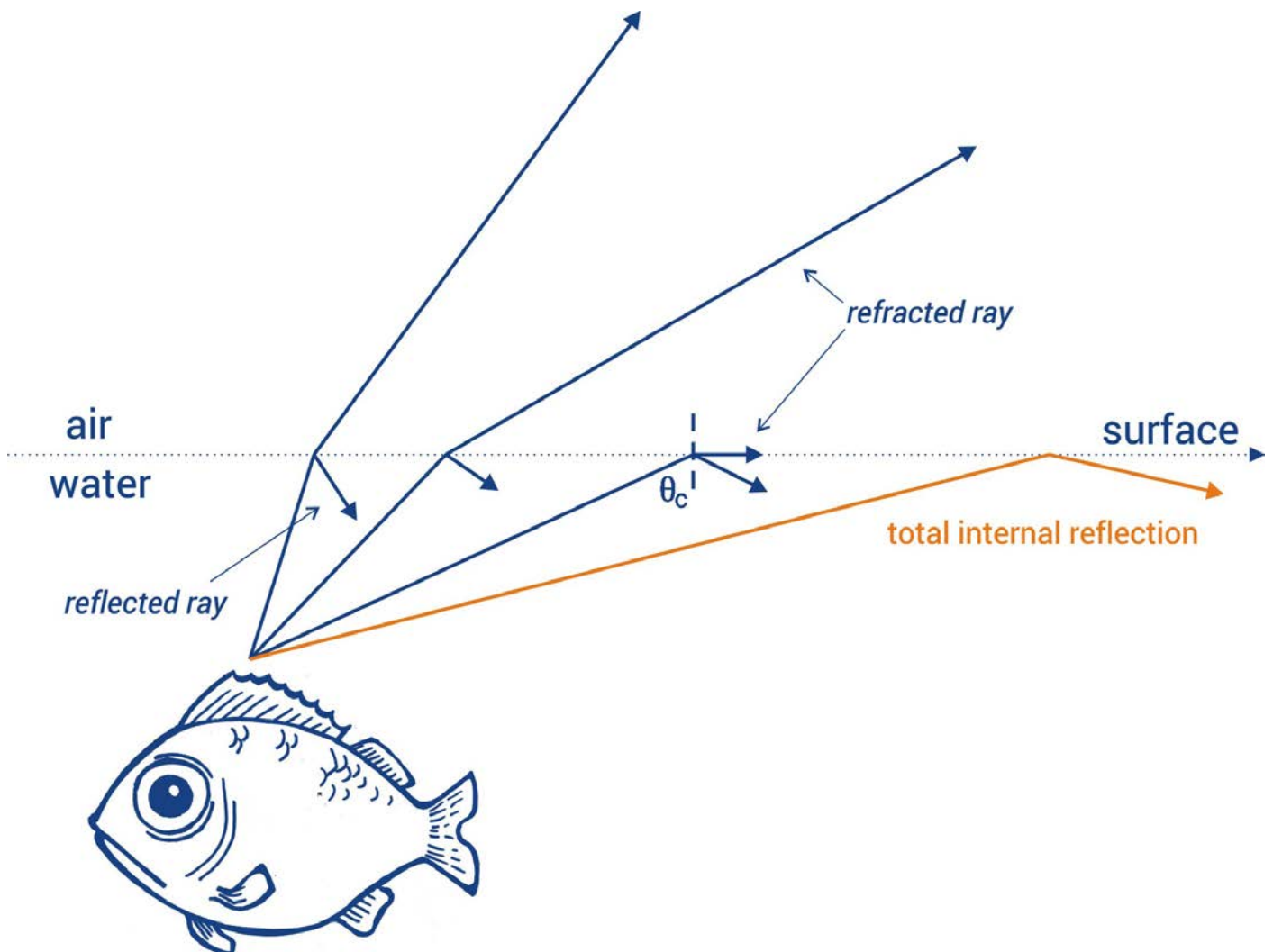
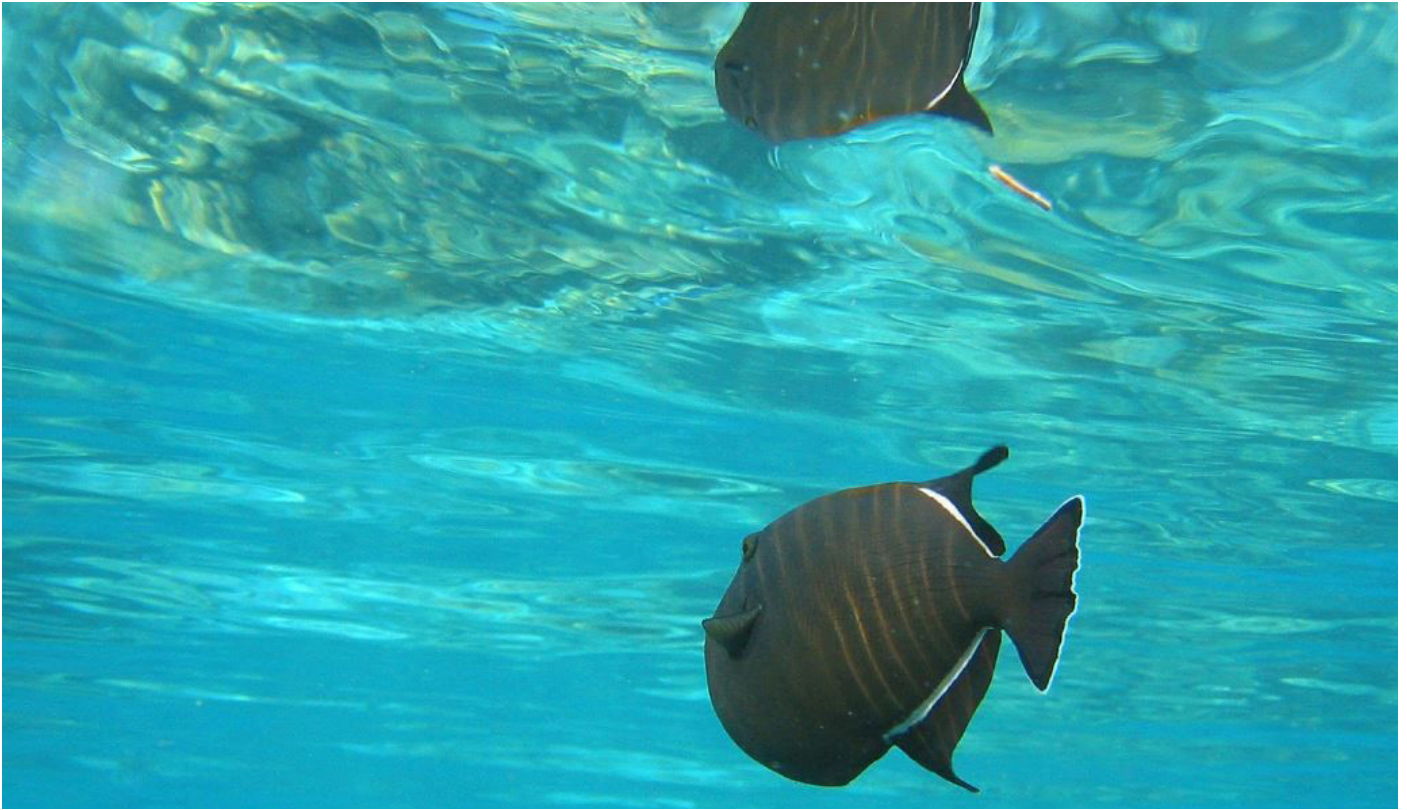

You can demonstrate this phenomena. Take a *glass with long, straight sides* or something similar and fill it with water. Mix a very small amount (ca. one drop) of milk into the water, and direct the laser beam into the glass, as shown in the picture.

The water surface is another kind of mirror, which only works if the light hits the surface under a **large angle of incidence** (the smaller the angle of incidence, the more the light gets lost through the surface). In order to demonstrate that this reflection obeys the same law as the reflection on a metal mirror, please increase the angle of incidence and show that it is the same as the angle of reflection.

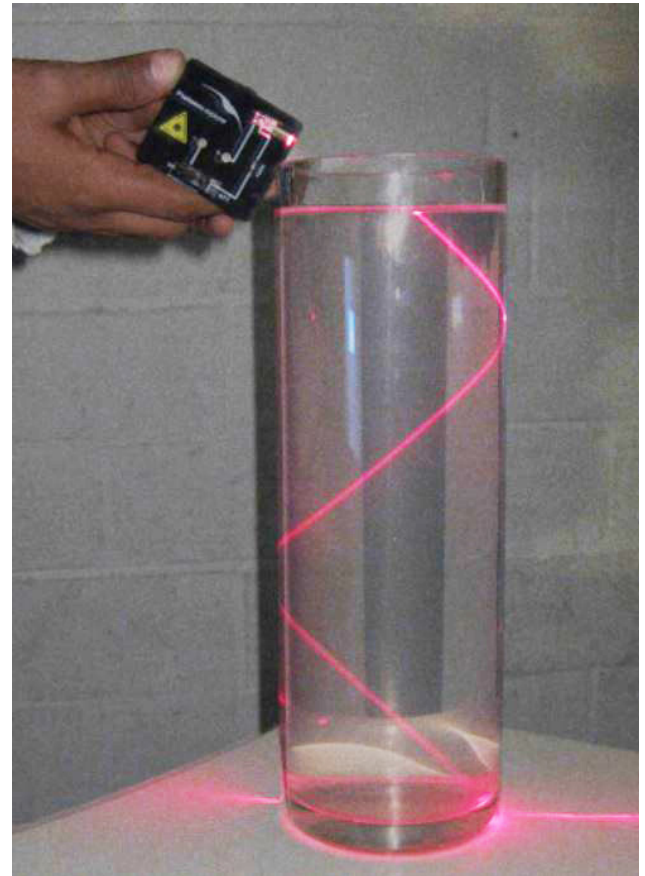
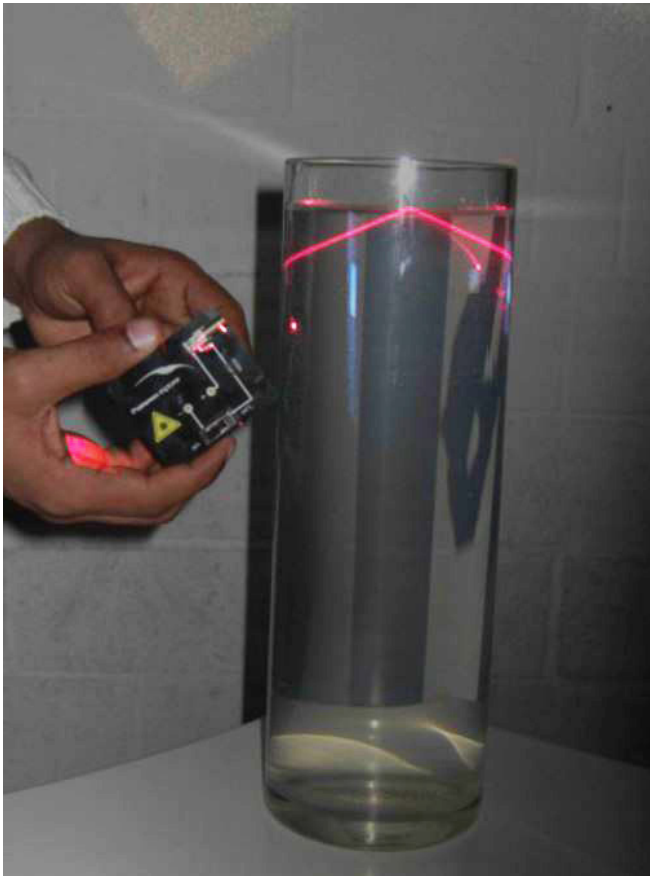

The laser beam will not leave the glass until it hits the bottom. You can see that the light beam becomes weaker and weaker. We can reduce this problem by having no milk in the water, however, without milk it would be much harder to see the beam. In order to make the light beam visible, some of the light has to be scattered by the milk droplet, which makes the beam weaker. Some light is also lost in reflections, if the angle of incidence is not large enough.

This effect is exactly the same in optical fibres as in the water glass, only the optical fibre is very long and thin and made out of plastic, which makes it flexible.
So, now you know all this, you can imagine what you need to give your cuddly toy bright eyes.

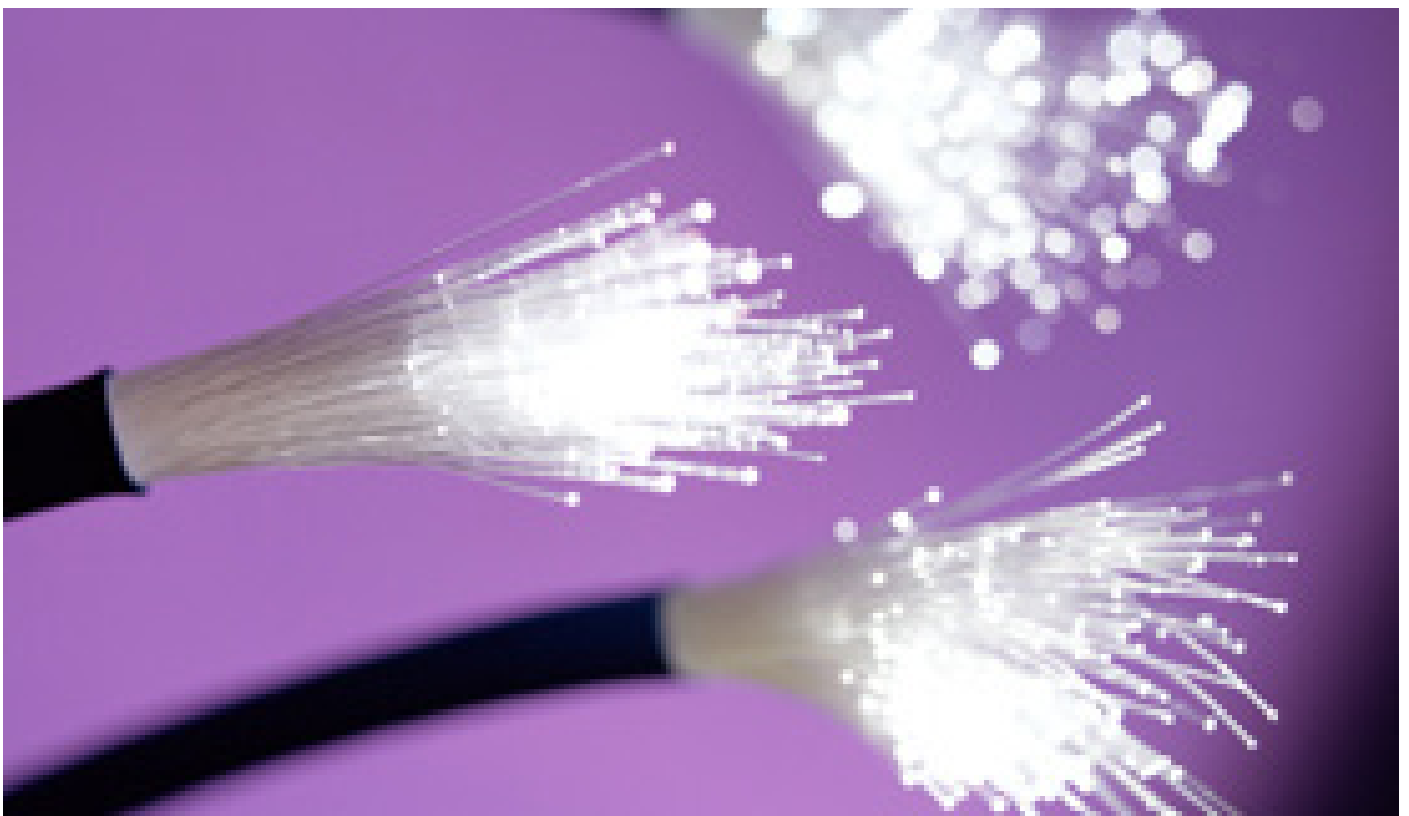
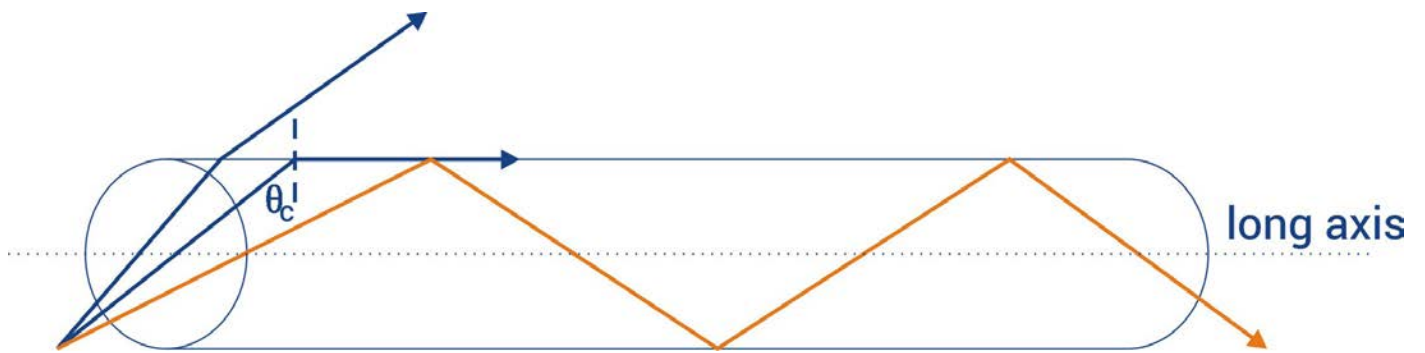

Step 2: Parts list

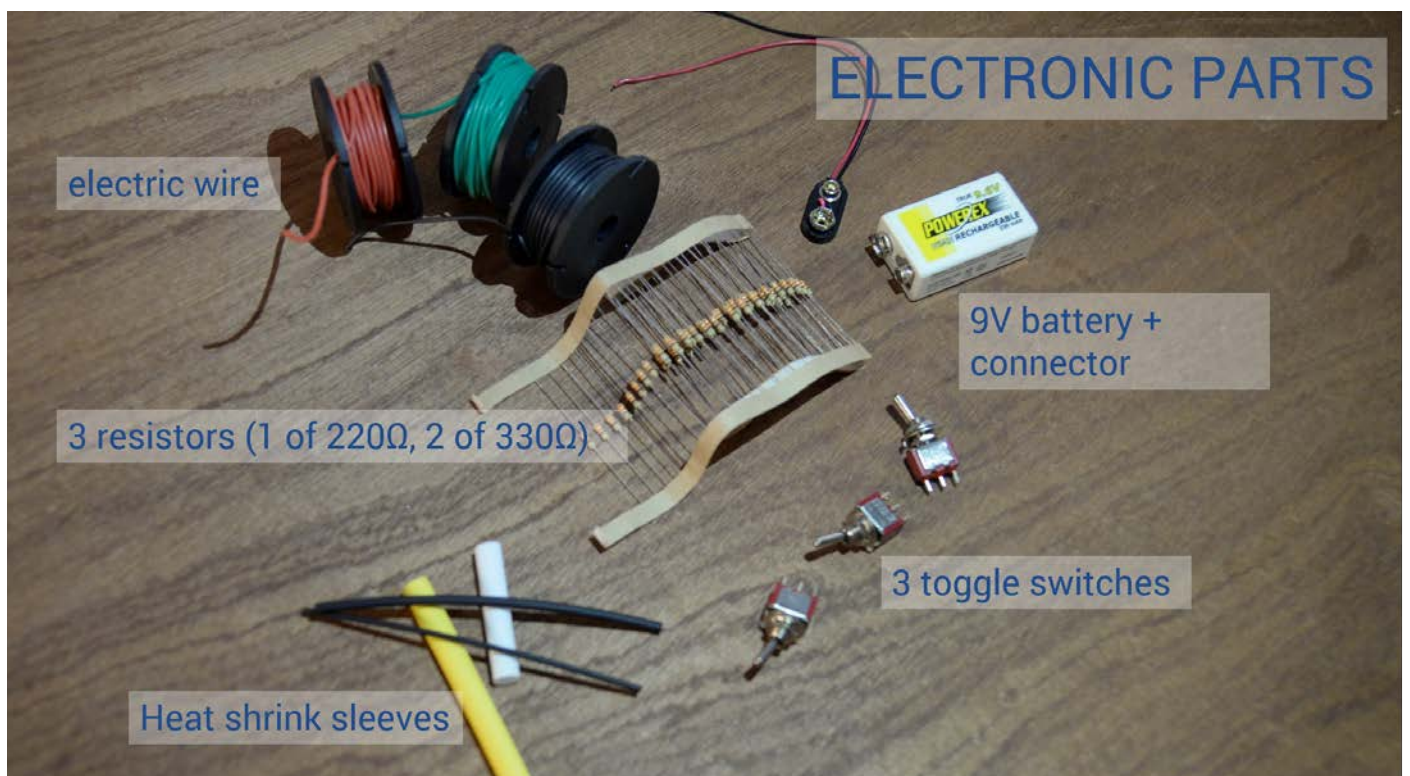
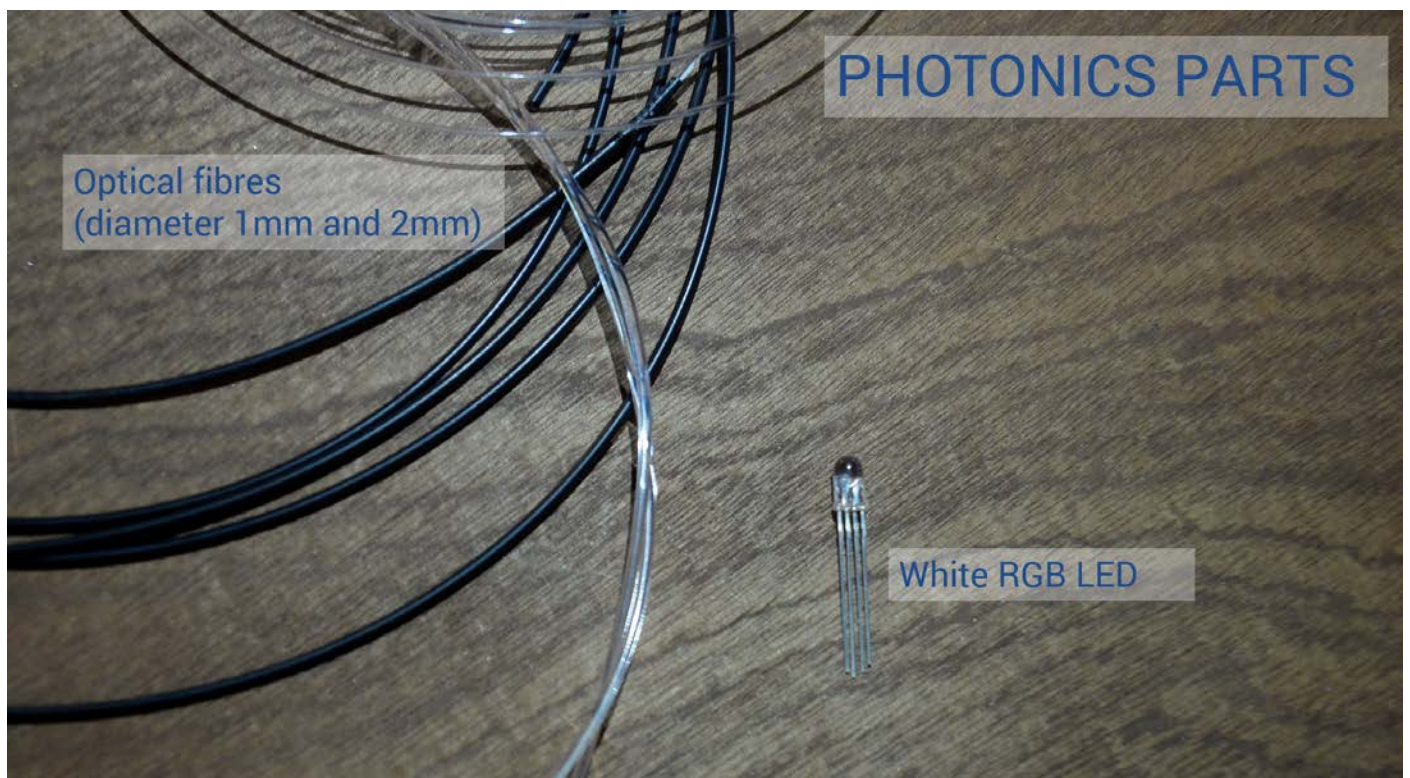

Collect all materials for each participant. Ask them to bring an old cuddly toy with them.

The photronics parts can be bought by [EYESTvzw](https://www.eyestvzw.com).

The electronic parts can be bought by [Fablabfactory](https://www.fablabfactory.com).

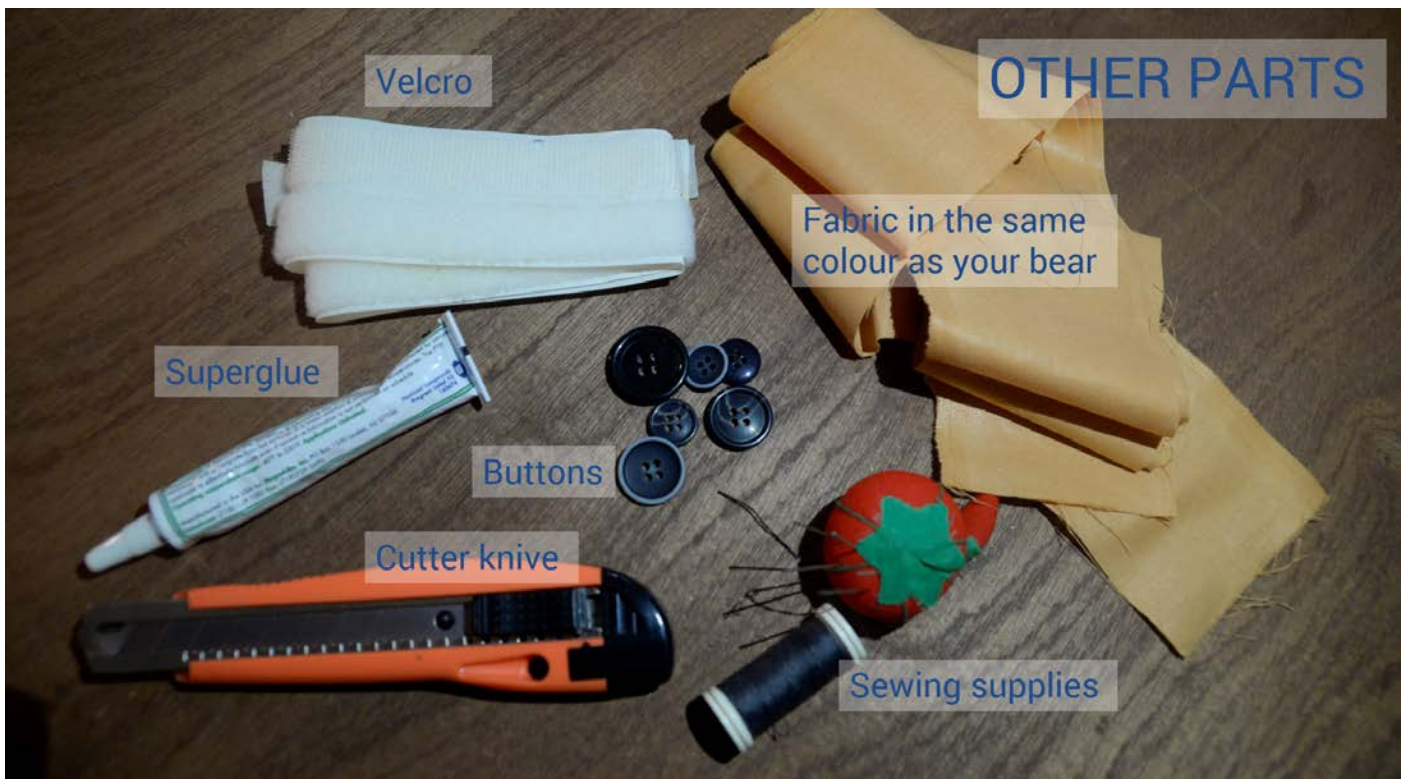

Step 3: Implementing optical fibres

The following step explains how to what you have to do first. Go through each step with the participants.

BASIC

[Instruction video on youtube.](#)

Open up (be careful!) the cuddly toy to insert the optical fibres. You can cut along the seams of the fabric of the cuddly toy with a cutter knife in order to not make a lot of damage.

Take out some of the **stuffing**.

The control box and battery will also go in this opening at the end of the workshop. In order to replace the battery when necessary, the battery should be easily accessible.

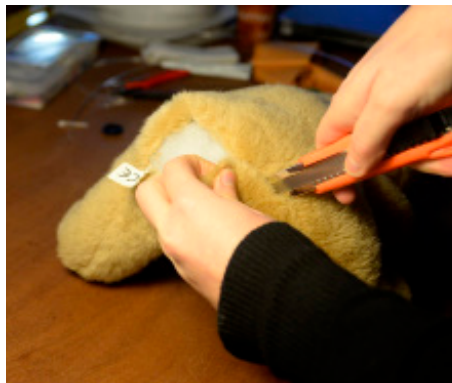
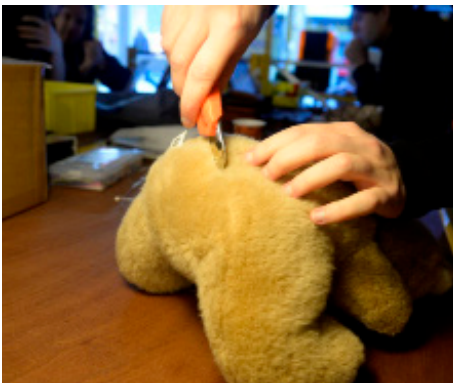

Since your bear is going to be re-opened again and again, we are going to **sew (sewing supplies)** some extra pieces of fabric with Velcro to the ends of the fur of the bear. (The extra piece of fabric is necessary to fully close the bear again.)

Measure the length of the two pieces of fabric to the ends of the fur.

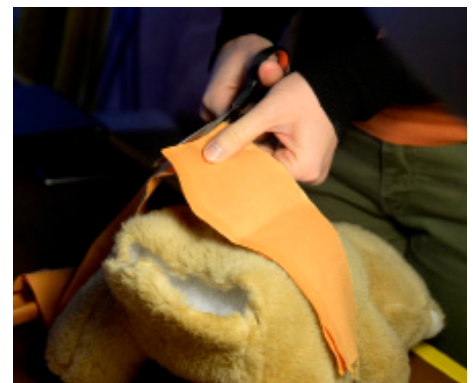
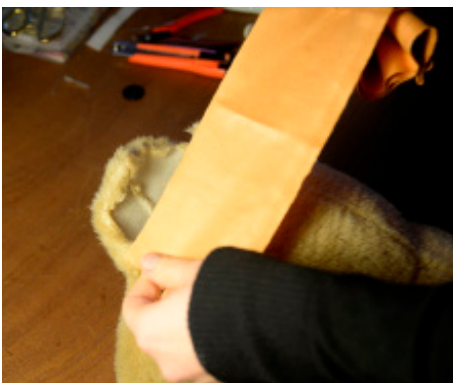

Measure also the length of the two pieces of Velcro. Sew one piece of the Velcro to one piece of fabric and sew the other one on the other piece of fabric.

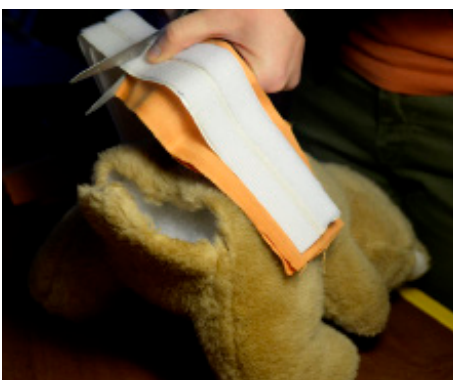

Attach the fabric with pins to the bear. And stitch the fabric to the fur of the bear. Note that you should be able to stick the two pieces of Velcro together. Remove the unnecessary wires.

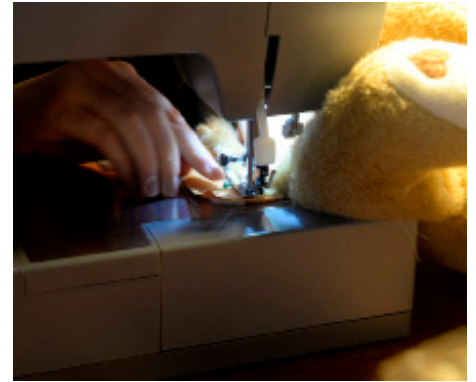

Use **buttons** to bring light to other parts of the bear. If you want some light in the belly of the bear, you should sew first a button, with preferably 4 holes in the preferred place.



Once you have the button where you want it to be, you can put an optical fibre through a hole of the button and through the fabric of the bear to the opening at his back. Attach a piece of tape around the end of the optical fibre, make sure the optical fibre cannot move anymore while working on the bear.



EXTENSION

For the participants who have more time:

If you have a lot of time, you can put several buttons on the bear, on each place you want to have light.



If you want to give your cuddly toy a lightning eye, you can drill a hole in the plastic eye. Use a drill head with the same diameter as the optical fibre you will use. (Note the safety precautions of this drill.)

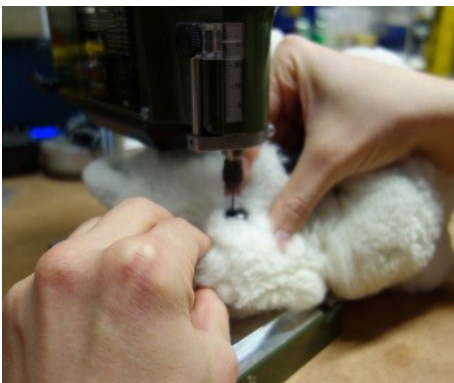

Pull the optical fibre through the drilled hole to the opening of the bear. Attach the optical fibre with superglue to the plastic eye. Make sure the optical fibre cannot move anymore while working on the bear.

Step 4: Side glow: EXTENSION

Now the participants have noticed that the light is only coming out the fiber at the end. Ask them if they know a way to have the light coming out the fiber sideways?

Prepare a fiber with sideglow as below and show the participants. Let them decide how long the sideglow part should be (the longer this sideglow is, the less light will come through, there is always a little loss)

Then follow step by step the instructions below with the participants.

This part is an extension to the workshop. This can only be done with the participants if you have more than 3 hours.

[Instruction video on youtube.](#)

If you send light at one side of an optical fiber, the light only comes out at the other side of the fiber. But it is also possible to have light coming out of the optical fiber at the side. For this you need to give the light access to come out, by making notches (that are deep enough) in a part of the fibre.

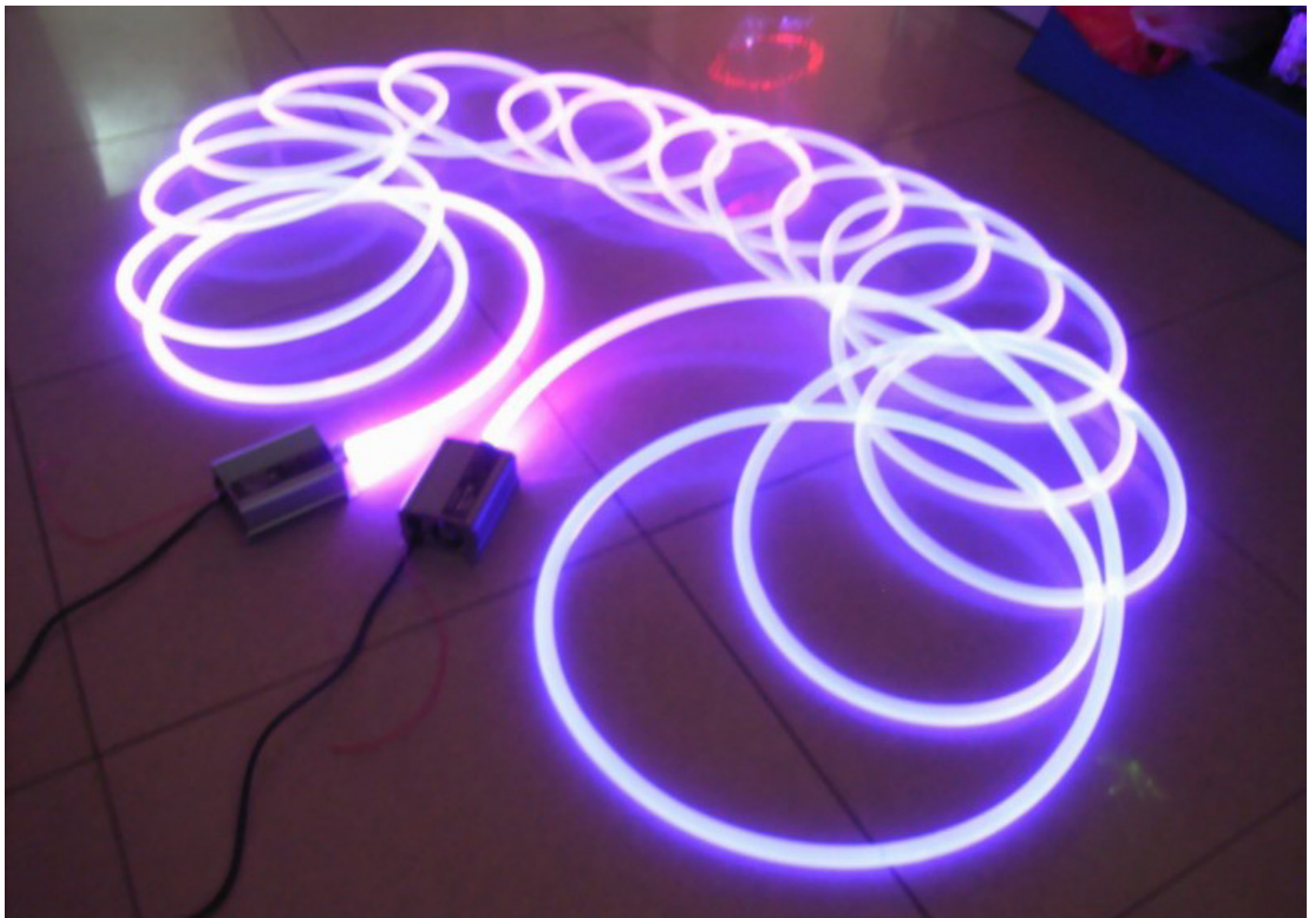
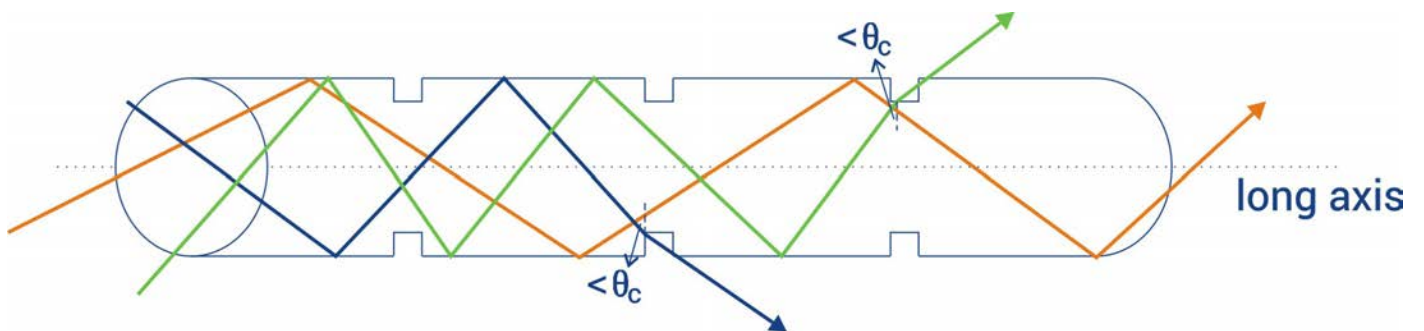

Say we would like to make the bear's hand glow in the dark. So we will attach **a fibre with side glow** effect on top of its hand.

The first step is to make notches in the optical fibre. For this side glow effect, we used optical fibres with a diameter of 2mm.

Make several notches next to each other, which are equally deep, over a certain distance. (Don't make this distance too long, otherwise the intensity of the light will decrease.) You can do this with a cutter knife, although this is not easy at all! If you are in a Fab Lab, use a **laser cutter** to make these notches.

The fibre gets weak after making notches in it, so it might break a lot easier when bending it. For this reason we already bent the fibre in the right angle and attached it like that on a wooden shelf. Make an **.svg file** to put in the laser cutter, or use ours (which you can find on the website www.PHABLABS.eu).

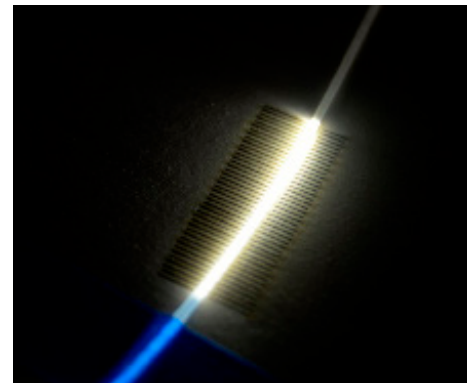
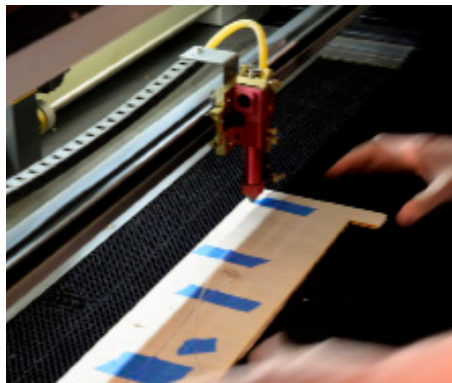
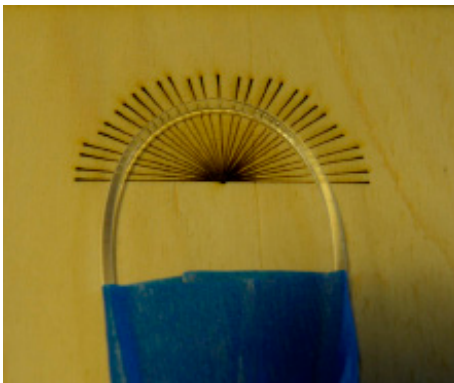

When removing the optical fibre from the shelf, make sure it stays curved, this to reduce the chance of breaking the fibre.

Make holes on each side of the bear's hand. Put the fibre through it, and remove the scotch tape. (The ends of the fibre should go to the end of the bear.)

Sew the fibre on the top of his hand in order to fix the fibre.

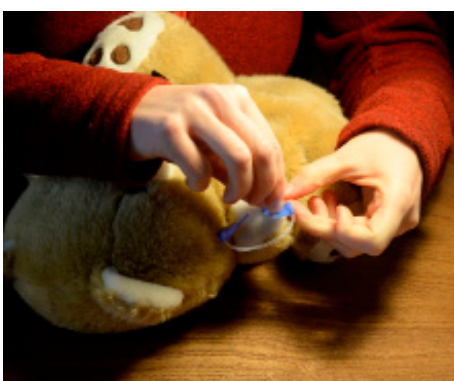
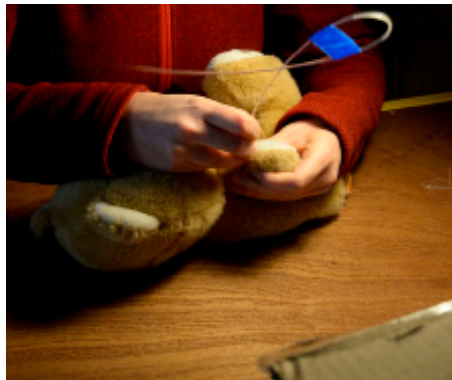

If you now send light through the optical fibre, you can see light coming through on top of the bear's hand.

You can use this principle to make a mouth for the bear, or to decorate his ears. Put the ends of the optical fibre through the fabric and bring the ends to the opening. Give a stitching on the underside of the arch of the mouth.



Step 5: Controlling & implementing LEDs

For the following instructions, you need plenty soldering irons. If these are not available (or the participants are too young to handle the soldering irons), you can also opt to use electric boards where they can put the components in and secure them with hot glue. Make sure the electric board fits the wooden box. Soldering the components is also more time consuming. The instructions of both options are explained in this step.

BASIC

[Instruction video on youtube.](#)

The only thing that is missing inside your bear is the light source. We are going to make a small box with the **LED and the control system**. We are going to use a white RGB LED, which can be controlled with three switches. (One for each colour).

We have soldered the components to each other like on the drawing below.

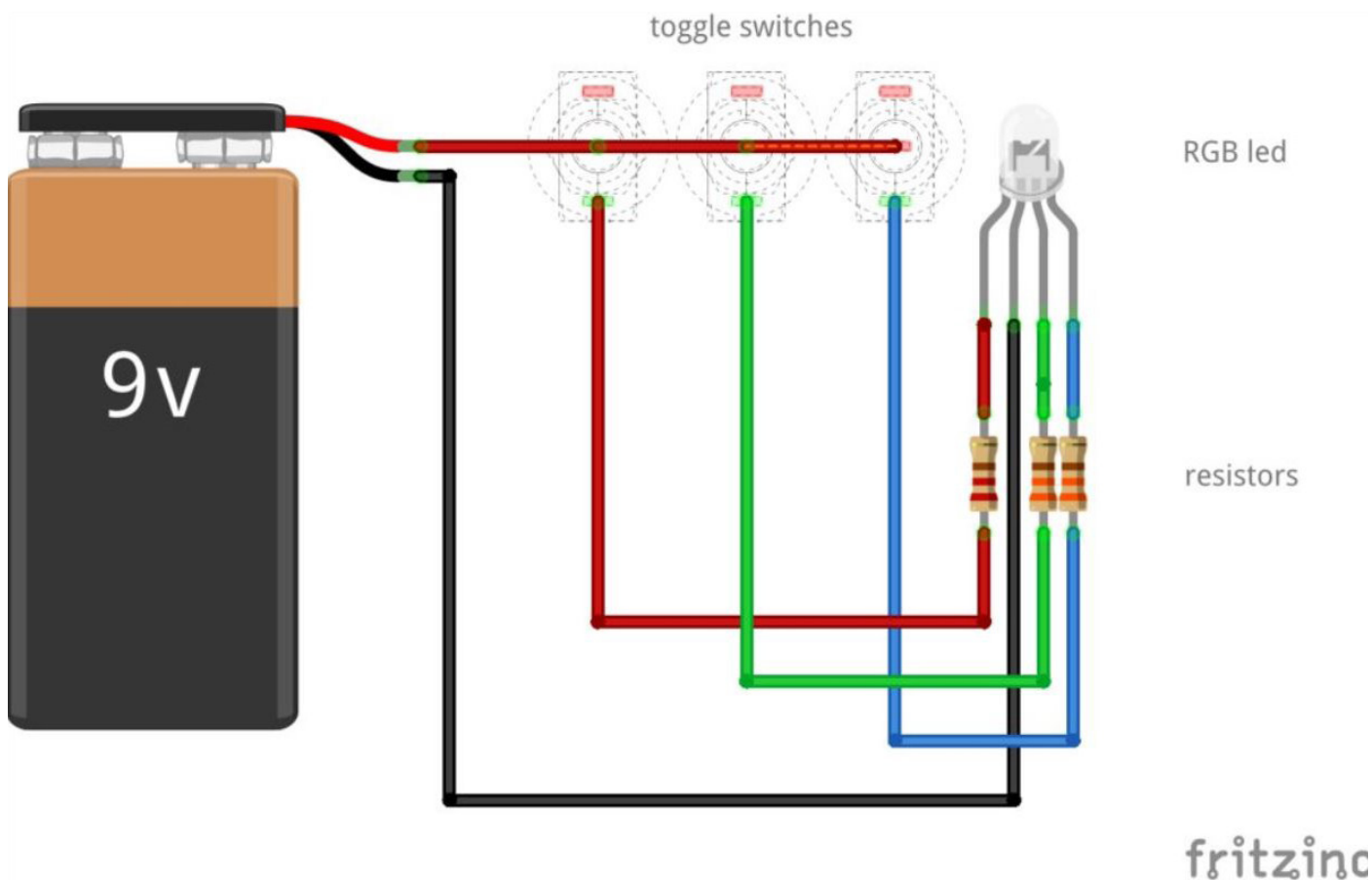

The RGB LED has 4 legs. The longest one is the one that needs to be connected to the **ground (GND)**. The leg at the left side of the longest leg, is for the red colour. The two at the right side are

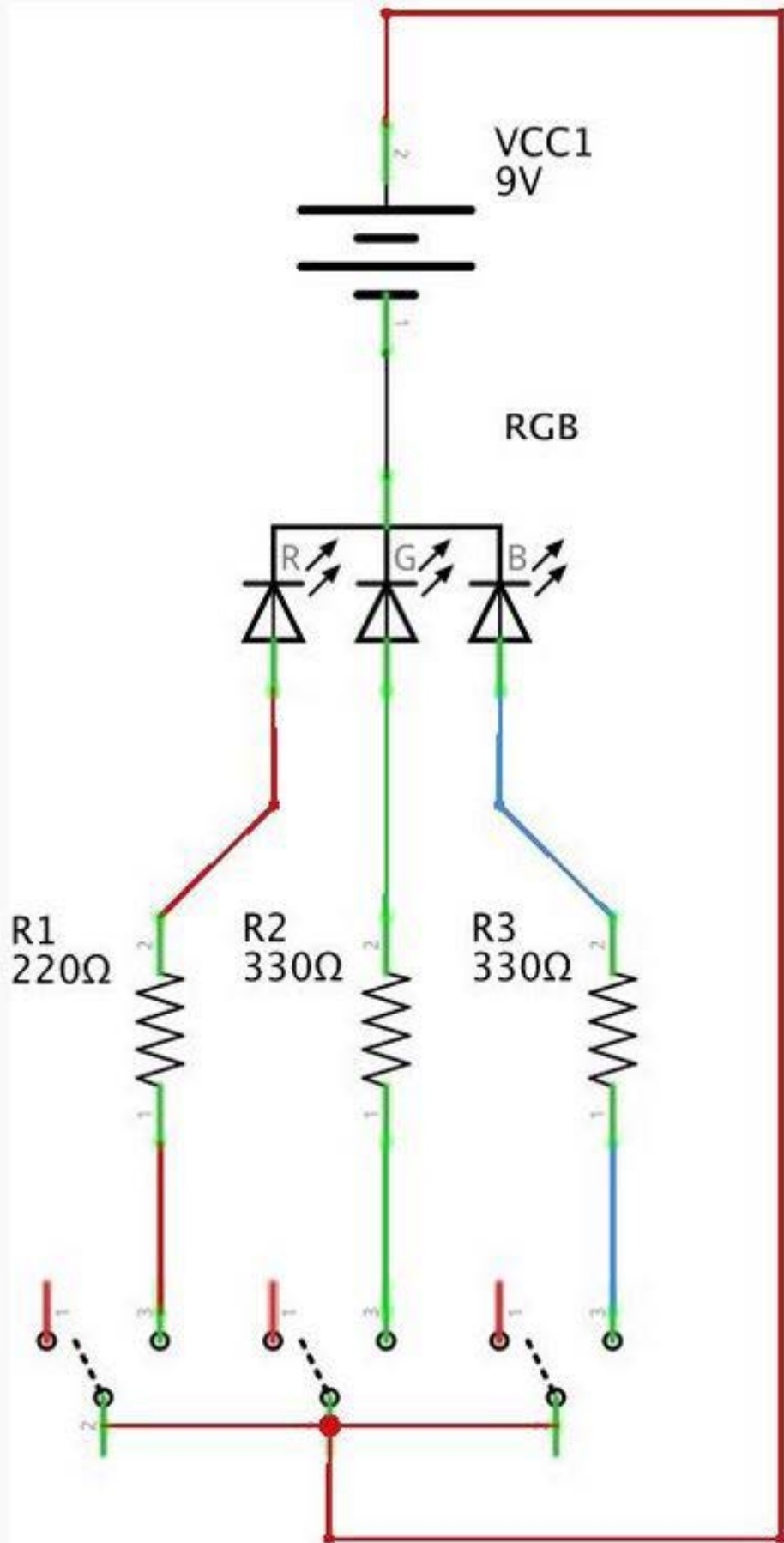

fritzing

respectively for the green and the blue colour.

The legs for the colours need to be connected first to a resistor. Use a **resistor of 220 Ω** for the red colour and **resistors of 330 Ω** for green and blue.

Start with soldering a resistor of 220 Ω to the leg for the red colour of the LED. Then solder a coloured electric wire (more or less 10cm) to the other side of the resistor. Put a heat shrink sleeve on top of

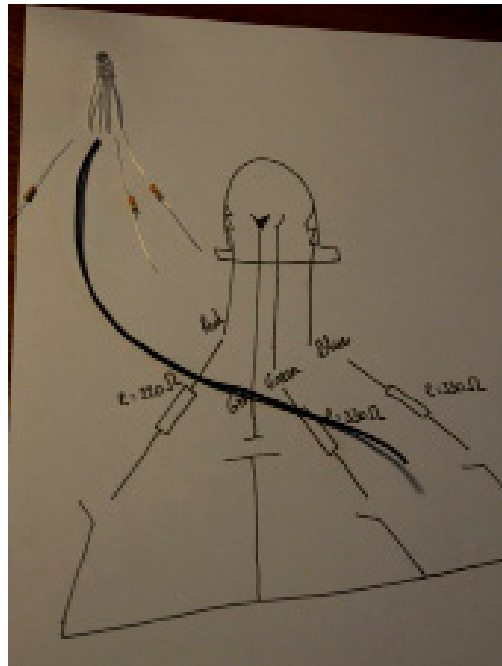

the resistor, make sure the total length of the resistor and all soldering is covered. Heaten up the shrink sleeve until it shrinks. Do the same with the other two colours (green and blue) of the white LED.

Solder a black electric wire (more or less 15 cm) to the longest leg of the LED. Cover the soldering with a heat shrink sleeve.

The ends of the three coloured electric wires (red, green and blue) now needs to be connected to a switch.

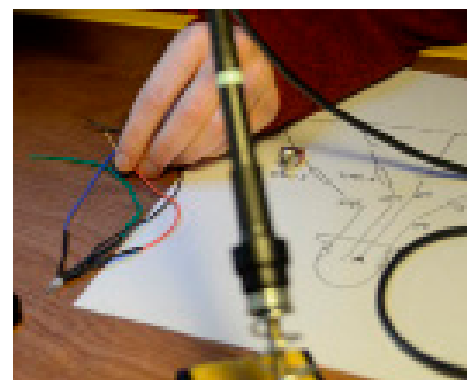
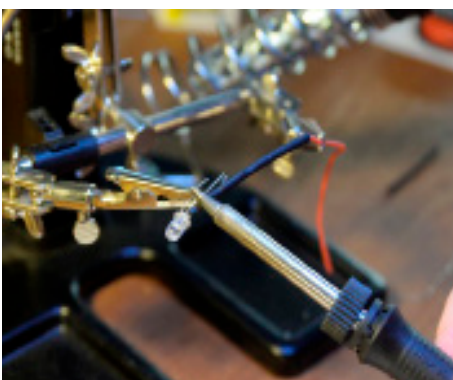
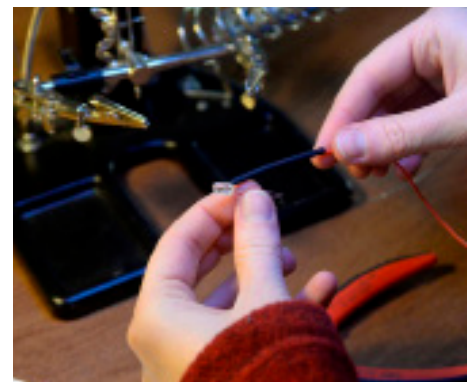

First cut small ends of heat shrink sleeves and slide them over the coloured electric wires. Weave the ends through a connector (the left or the right side) of the switch. Then solder these connections and cover the soldering with the heat shrink sleeve.

The next step is to interconnect the switches in series and connect them with the positive pole of the battery. Here for you need one red electric wire of about 15 cm and two shorter red electric

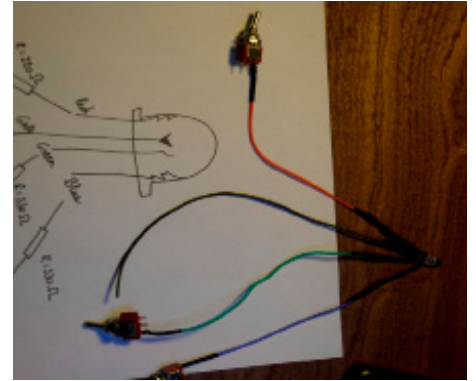
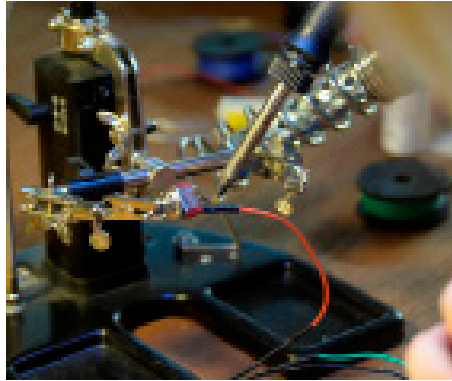

wires of about 6 cm.

I started to solder one end of a short red electric wire and one end of the longer red electric wire together to the middle connector of the switch of the blue colour. Before weaving and soldering those electric wires to the middle connector, make sure you first add a short piece of heat shrink sleeve on top of both wires. After soldering the ends to the connector, cover it with the sleeve and heat it up.

Then solder the other end of the short red wire (starting at the switch for the blue colour), together with an end of the second short red wire to the middle connector of the switch for the green colour. (Don't forget the heat shrink sleeve!)

Finally solder the last end of the short wire to the middle connector of the switch for the red colour. (Don't forget the heat shrink sleeve!)

Use the laser cutter to make the wooden box. Provide in this box holes for the switches, holes for the connection of the battery and holes for the optical fibers. The unfolding drawing can be made

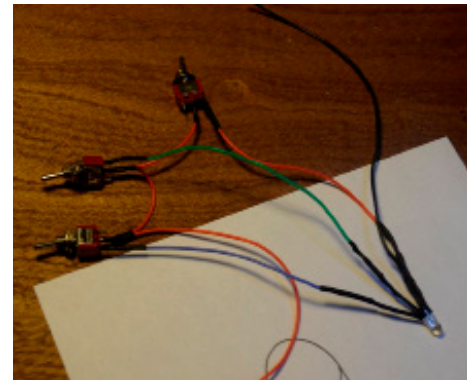
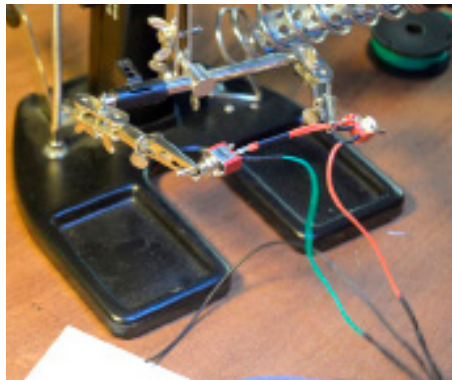

in <http://www.makercase.com/> Or you can use our .svg file.

[Instruction video on youtube.](#)



In order to prepare the fibres to put into the wooden box, stick all fibres in the bear together and cut them to the same length.

Assembling the box and all components requires patience and attention.

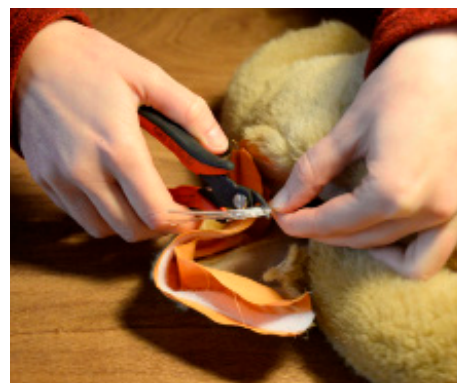
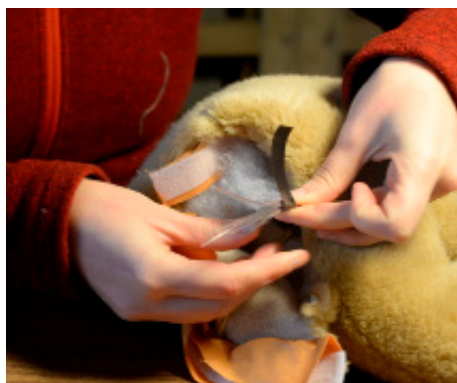

Start with the battery connector. Insert the wires of the connector through the foreseen holes in the wooden box. Make a knot in the wires. Strip the ends of the wires and solder them to the ends of the red and black wires on the LED. (Don't forget the heat shrink sleeve.)

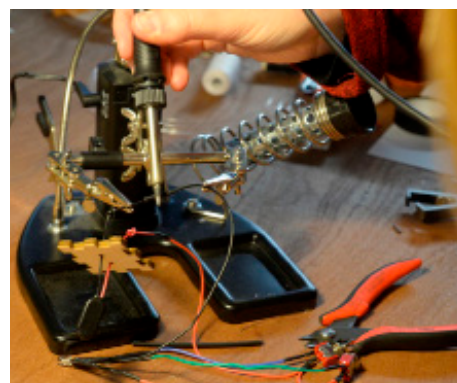
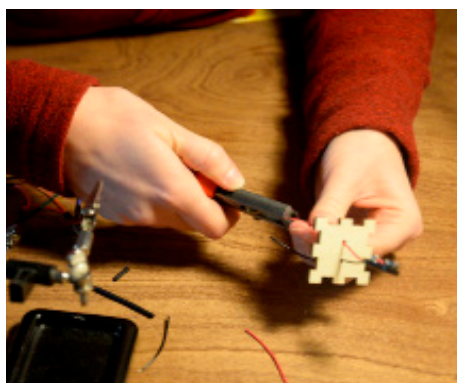

Insert the switches into the holes in the box. Secure the switches with nuts to the wooden box.

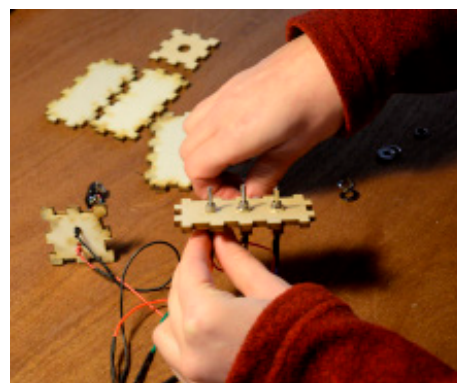
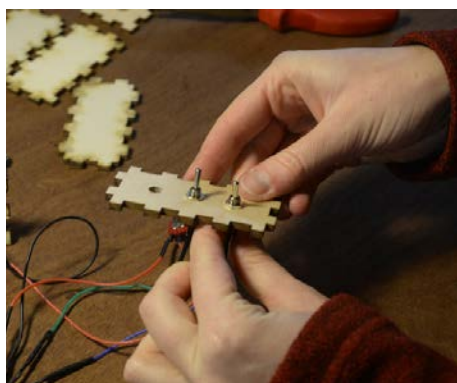

Now glue five sides of the box together.

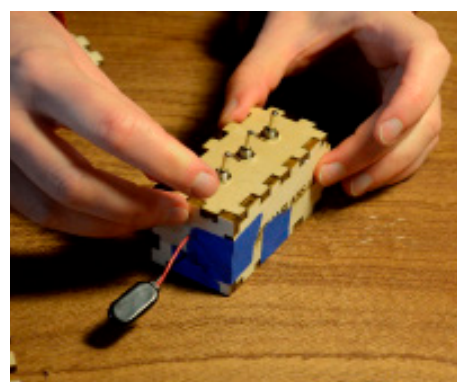
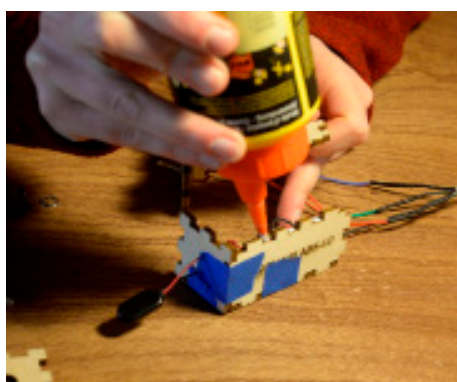
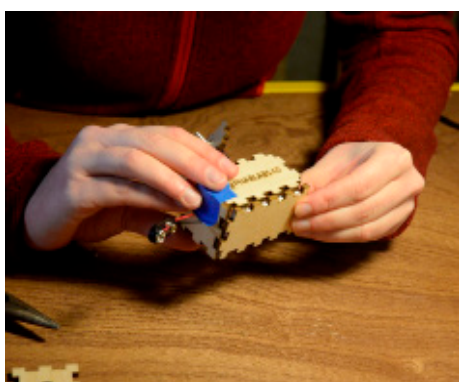

The connection between the LED and the fibres in the bear is made with a plastic flexible tube. Use such a tube with length of 4cm that just fits around the fibres. Make sure the LED and the fibres are closely to each other.



Next put all fibres into the wooden box and glue everything together.

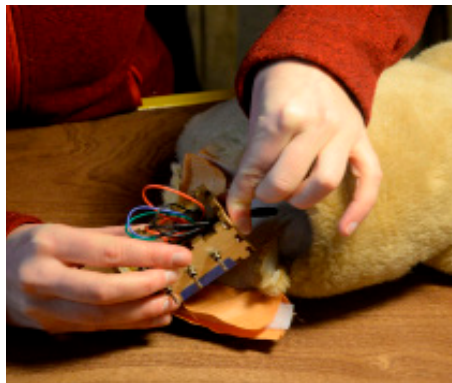

Make three holes in the back of the bear and put the switches through those holes. Secure the switches with nuts to the fur of the bear.

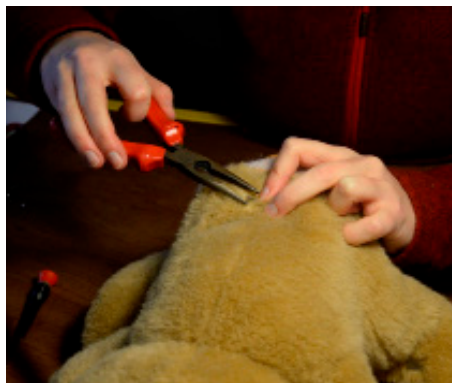
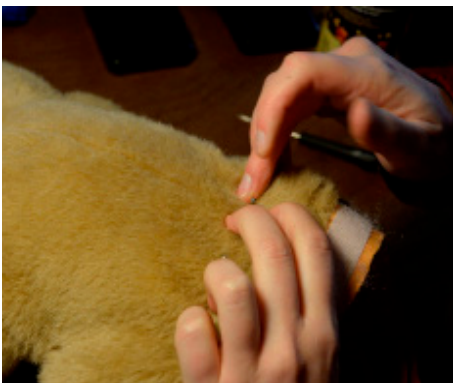

Add a battery to the connector and put the box into the bear. Put some stuffing back into the bear as well.

Close him with the Velcro.

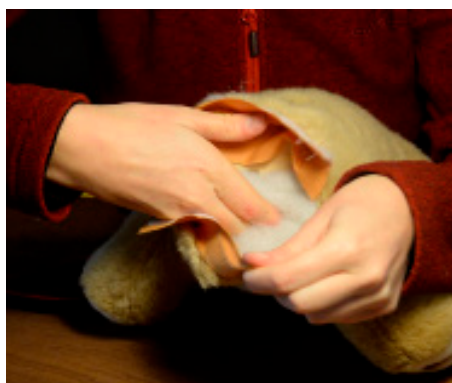

In case you don't have enough soldering irons available in your fablab, or you would like to win some time, you can opt for a second method to control and implement the LEDs.

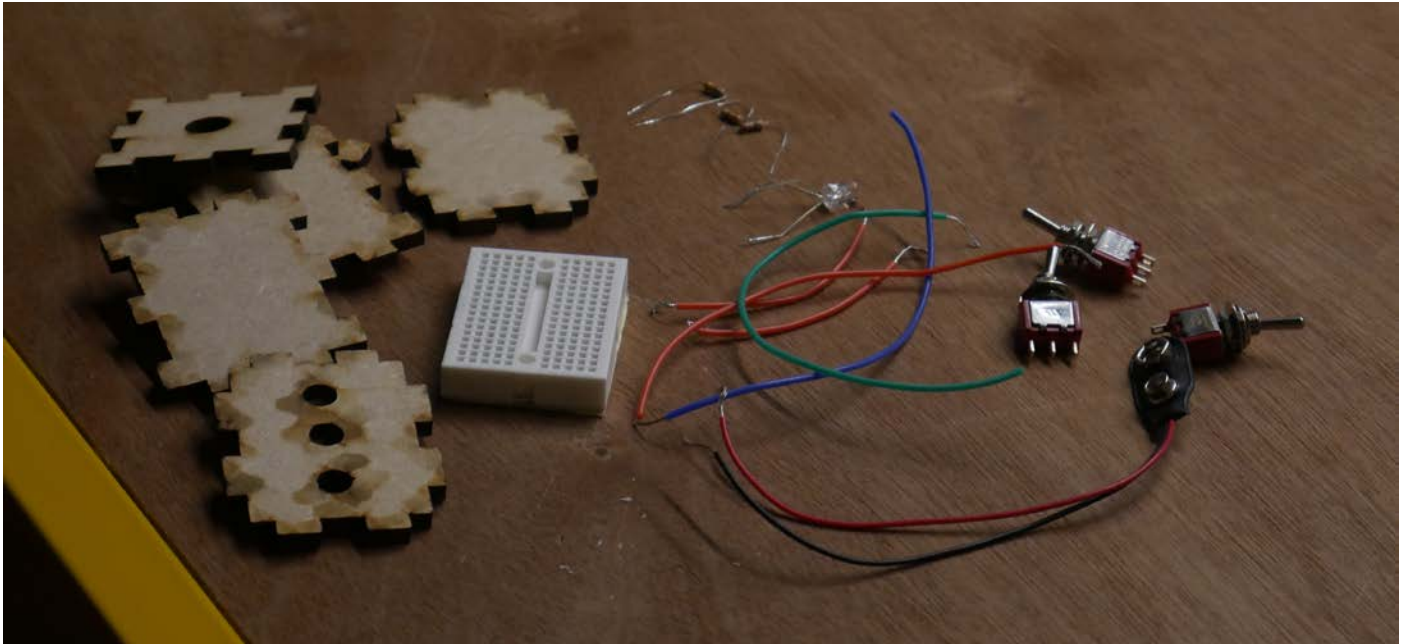

Materials needed:

- White RGB LED
- 3 resistors (1 of 220 Ohm, 2 of 330 Ohm)
- Electric wire
- Heat shrink sleeves
- 3 toggle switches
- 9V battery + connector
- Electronic board

Use the laser cutter to make the wooden box. This one we use here has slightly different dimensions than the one we used with the soldering. Provide in this box holes for the switches, holes for the connection of the battery and holes for the optical fibers. The unfolding drawing can be made in <http://www.makercase.com/> Or you can use our .svg file.

The electronic board has double sided tape on the back. Remove the protective film and attach the electronic board to the underside of the wooden box.

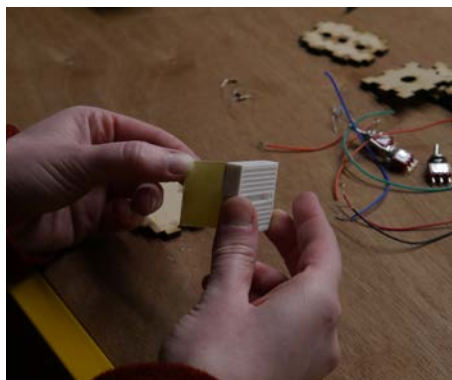

The RGB LED has 4 legs. The longest one is the one that needs to be connected to the **ground (GND)**. The leg at the left side of the longest leg, is for the red colour. The two at the right side are respectively for the green and the blue colour.

The legs for the colours need to be connected first to a resistor. Use a **resistor of 220 Ω** for the red colour and **resistors of 330 Ω** for green and blue.

The legs of the white LED and of the resistors are too long. Shorten those legs a little in order to have a clean electronic board. Bend those legs in the right corner in order to put them straight in the wholes.

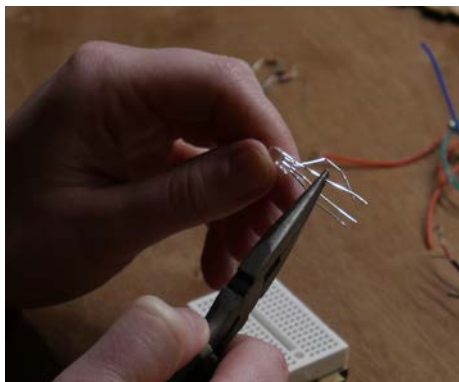

Put the components in the right place on the electronic board. Make sure you use the right resistor with the right leg!

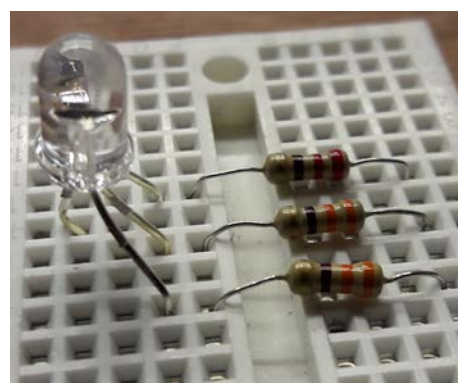
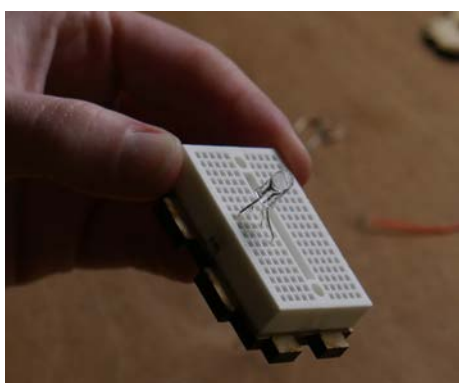

The ends of the three coloured electric wires (red, green and blue) now needs to be connected to a switch.

First cut small ends of heat shrink sleeves and slide them over the coloured electric wires. Weave the ends through a connector (the left or the right side) of the switch. Tighten it up by turning the electric wire around each other. Cover this connection with the heat shrink sleeve. Heaten up the heat shrink sleeve to let it shrink around the connection. (This can be done with a candle light or with a hairdryer). Repeat this for the three coloured wires (red, green and blue)

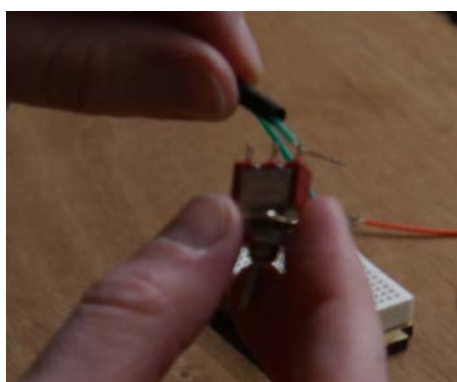
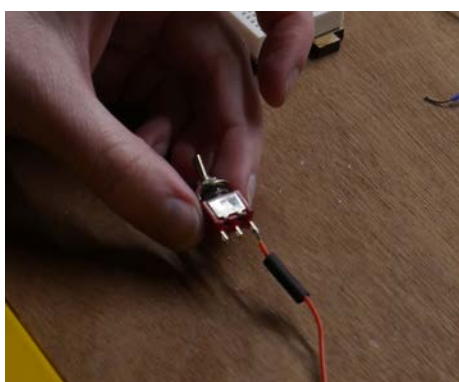

The next step is to interconnect the switches in series and connect them with the positive pole of the battery. Here for you need one red electric wire of about 15 cm and two shorter red electric wires of about 6 cm.

Start with weaving one end of a short red wire to the middle connector of the switch of the red colour. Cover the connection with a heat shrink sleeve.

Then solder the other end of the short red wire (starting at the switch for the red colour), together with an end of the second short red wire to the middle connector of the switch for the green colour. (Don't forget the heat shrink sleeve! You should add it on top of both wires before weaving it to the connector.) Cover the connection with the heat shrink sleeve and heat it up.

Insert the wires of the battery connector through the foreseen holes in the wooden box. Make a knot in the wires. Strip the ends of the wires.

Then weave the other end of the short wire (starting at the switch for the green colour), together with the longer red electric wire from the battery connector to the middle connector of the switch of the blue colour. (Don't forget the heat shrink sleeve!)

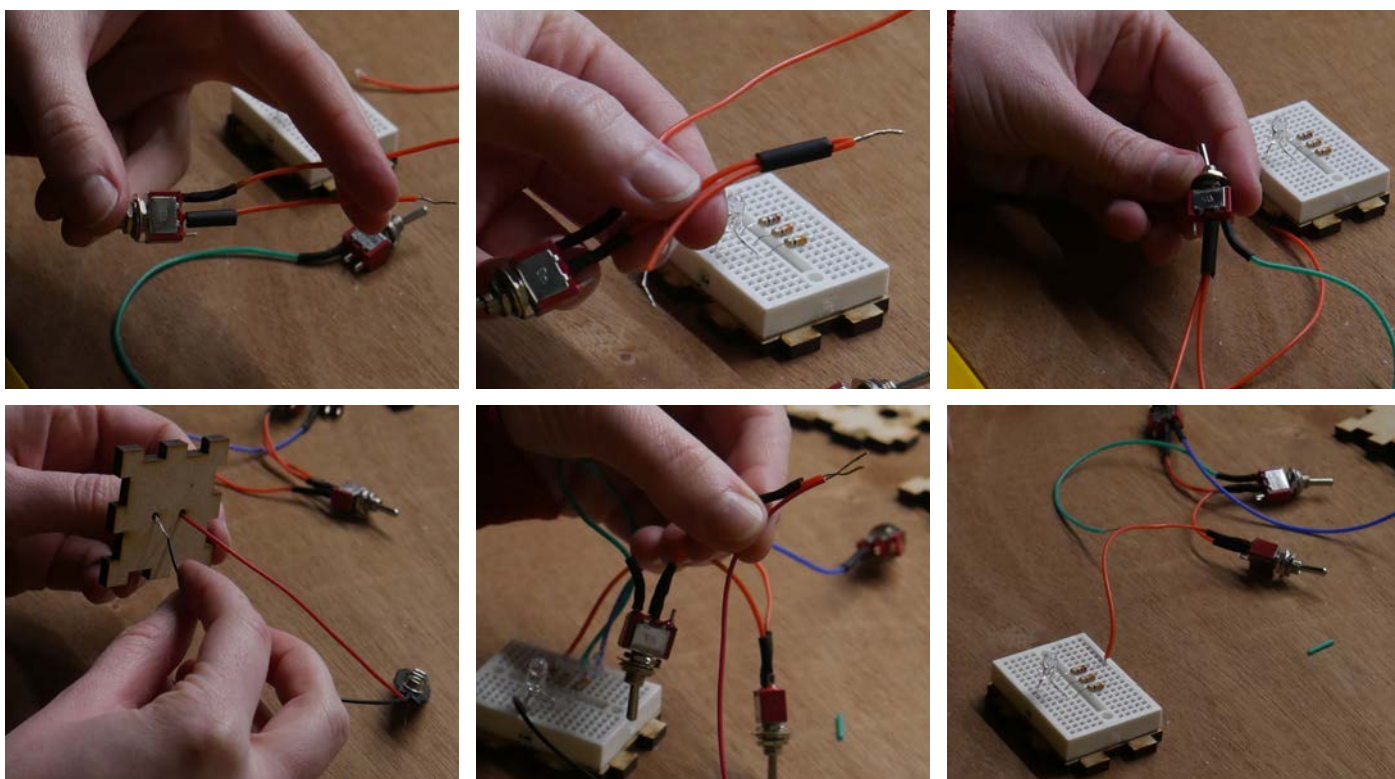

Put the red, the green and the blue wire, coming from the switches into the electronic board in such a way that they connect with the right resistor.

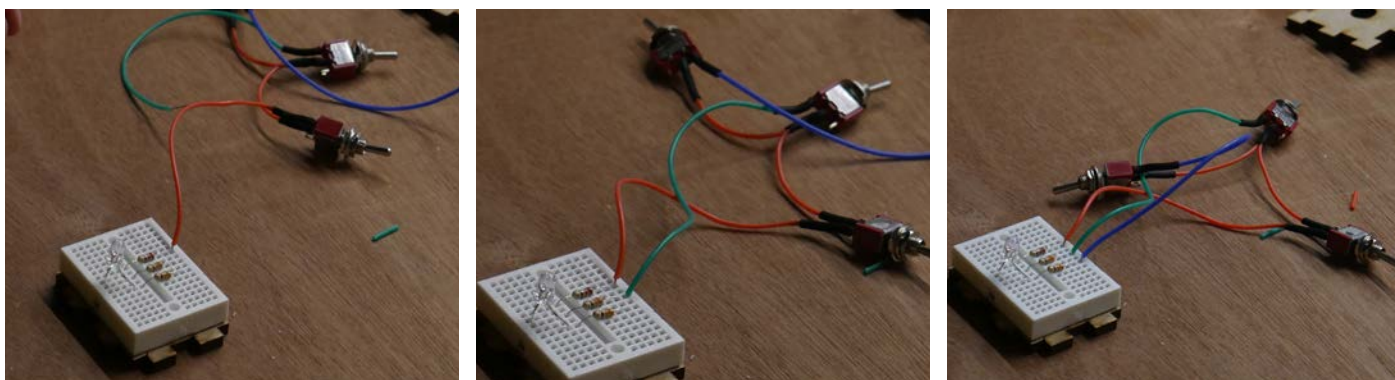

Make sure the connections on the electric board will not come loose, by secure them with hot glue to it.



Connect the black wire of the battery connections to the GND (ground) leg of the white LED. Secure this connection on the electric board also with hot glue.

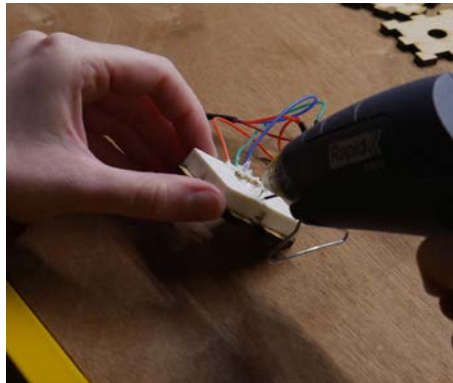
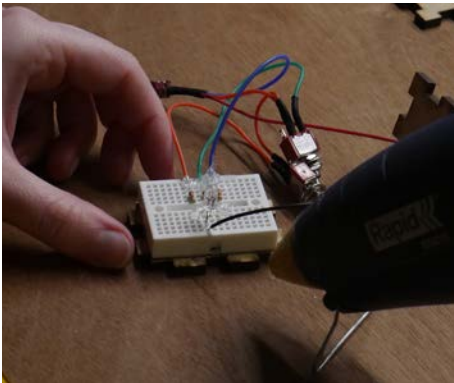

Glue the wooden side part with the holes for the battery connector to the lowerside of the wooden box. Do the same with two other side parts.

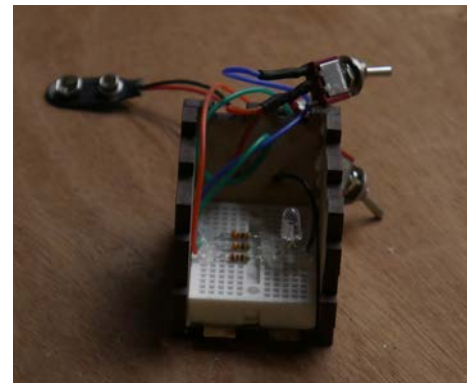
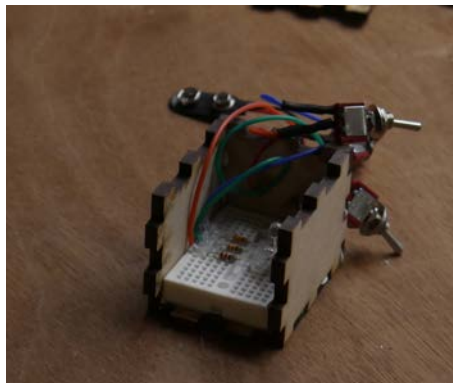

The connection between the LED and the fibres in the bear is made with a plastic flexible tube. Use such a tube with a length of 4cm that just fits around the fibres. Put the fibres through the wooden side part with the big hole. Put the plastic tube over the top of the fibres and LED. Make sure the LED and the fibres are closely to each other.

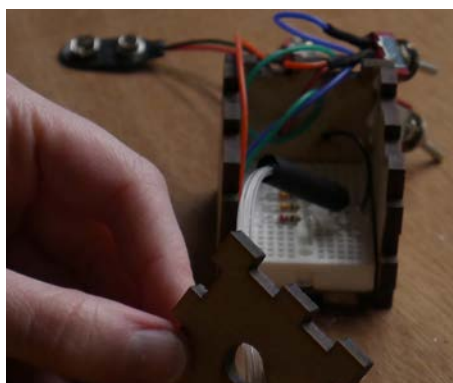
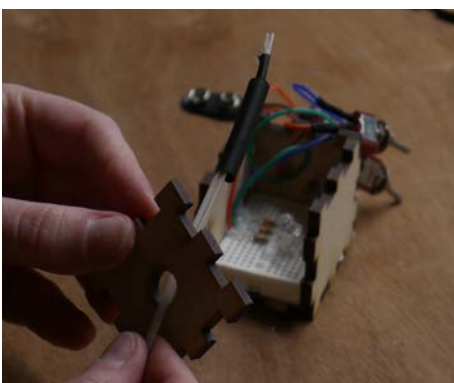

Insert the switches into the holes in the box. Secure the switches with nuts to the wooden box.

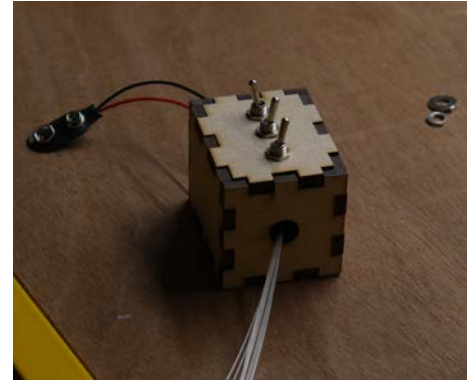
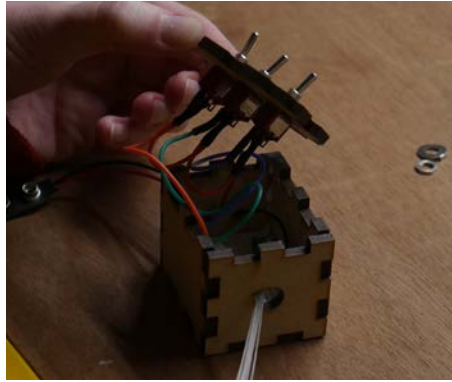
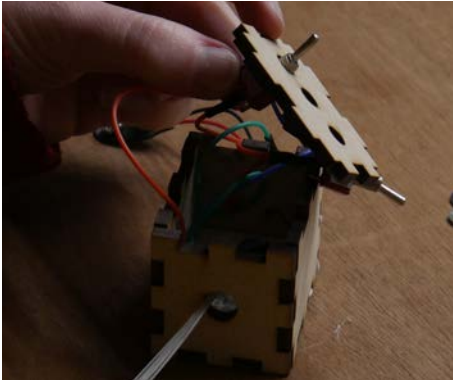

Make three holes in the back of the bear and put the switches through those holes. Secure the switches with nuts to the fur of the bear.

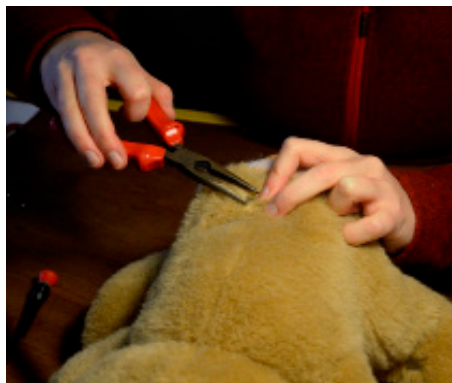

Add a battery to the connector and put the box into the bear. Put some stuffing back into the bear as well. Close him with the Velcro.



Almost there :)

The final step is to secure the optical fibres to the button. Use super glue for this. After letting it dry a little, cut the fibres so they don't stick out of the button anymore.



Now the Photonics Cuddly Bear is finished.
Play with the switches and make all colours you want.



EXTENSION

You can also make use of a second LED. Then you can split your bundle of fibres in two, one for each LED. The soldering is similar as above. But attach the red wires of both the LEDs together and eventually to the battery, and do the same for the black wires.

Step 6: End result & conclusions

What we learned?

You learned to use your creativity to approach complex challenges. You learned how to solder simple electric components.

If you are giving this workshop to a group of youngsters, you can invite the parents over and organise a public showing. This to involve the parents, so they can engage the youngsters to come more often to the Fab Labs.

If someone might ask you where optical fibers are used to in real-life, you can tell them the following facts.

Concluding thoughts

Thanks to the invention of the optical fibre, it is possible to send light signals over hundreds of kilometers. The email from a friend in Australia and the internet blog with party pictures from Hawaii - they all travel around the globe in a light flash.

Light is fast. In fact, no object can move faster than light.

Light travels straight, unless it hits an object.

Sending light signals over many mirrors is very difficult. It is much easier to use flexible optical fibers to guide the light by total internal reflection.

Light highways on the ocean floor.

When you look up a website on the internet, it is very possible that the information you see has been sent to you as short light flashes through optical fibres over thousands of kilometres. The technique is the same as the one you used in the bear. But instead of red, green, and blue light signals, modern systems send and receive very short light flashes in 80 different colours in parallel. By packing several fibres together to an optical cable, such systems can send tremendous amounts of information all over the globe extremely fast. For instance, a single cable lying on the ground of the Mediterranean Sea between Egypt and France can send 10 TB (10¹² byte) data per second – the equivalent of 16,000 CD ROMs, or everyone living in France having two phone conversations simultaneously! Similar cables connect all the continents of the globe (except Antarctica). Without this international network of light signals, the internet as we know it would simply not exist. Can you imagine all these light flashes rushing around the globe? In principle, it is just the same as you might have proposed for the villages in the Andes – just on a larger scale.



PHABLABS 4.0

PHABLABS 4.0 is a European project where **two major trends** are combined into one powerful and ambitious innovation pathway for digitization of European industry:

On the one hand the growing awareness of **photonics** as an important innovation driver and a **key enabling technology** towards a better society, and on the other hand the **exploding network of vibrant Fab Labs** where next-generation **practical skills-based learning** using KETs is core but where photonics is currently lacking.

www.PHABLABS.eu

This workshop was set up by the *Brussels Photonics Team, Vrije Universiteit Brussels* in close collaboration with *Fablabfactory*.



B-PHOT
BRUSSELS
PHOTONICS



PHOTONICS PUBLIC PRIVATE PARTNERSHIP



B-PHOT
BRUSSELS
PHOTONICS



STEINBEIS
2i



UNIVERSITY OF
Southampton



Technische
Hochschule
Wildau
Technical University
of Applied Sciences



Leibniz
Ferdinand
Braun
Institut



CENTER
FOR PHYSICAL SCIENCES
AND TECHNOLOGY



NUI Galway
OÉ Gaillimh

JOANNEUM
RESEARCH

